

TEETH: 3
HOOK: 10°
SHEAR: 0°
TIPS: INSERT
PA: N/A

MAX RPM: 14,000

DWG: 4-01-3317500

A.K.A. #: N/A

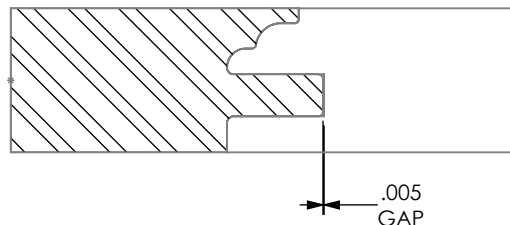
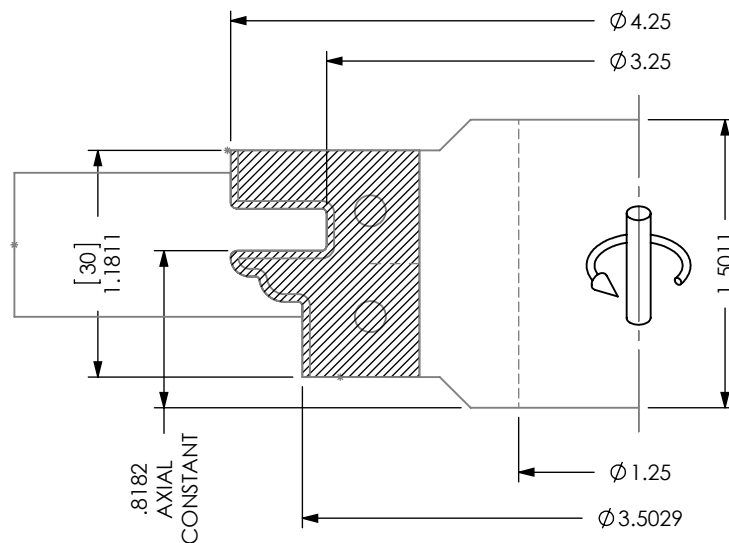
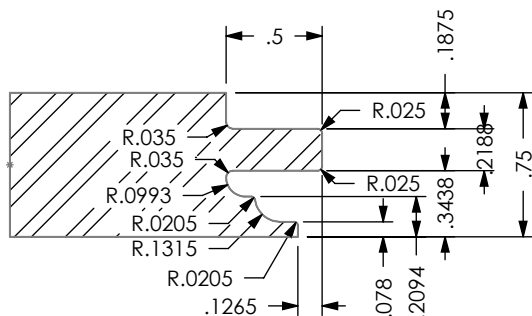

HALL MANUFACTURING DWG: 4-01-3317500

ATTN: _____ DATE: _____ PO#: _____

**CUSTOM TOOLING MUST HAVE CUSTOMER APPROVAL PRIOR TO THE START OF
 MANUFACTURING. PLEASE REVIEW THIS DRAWING FOR ACCURACY, INCLUDING
 ROTATION, AND FAX A SIGNED AND DATED COPY. PRODUCTION
 WILL BEGIN UPON RECEIPT OF APPROVED DRAWING.**

APPROVED BY: _____ DATE: _____

DATE:
7/15/15

DWN BY:
R.A.Y.



REV.
 + SHEET 1 OF 5