

TEETH: N/A
HOOK: N/A
SHEAR: N/A
TIPS: INSERT
PA: N/A

DWG: 4-10-2208700

A.K.A. #: RUC91821
RUC91822

#4-10-2208700
#RUC91821

#4-10-2208800
#RUC91822

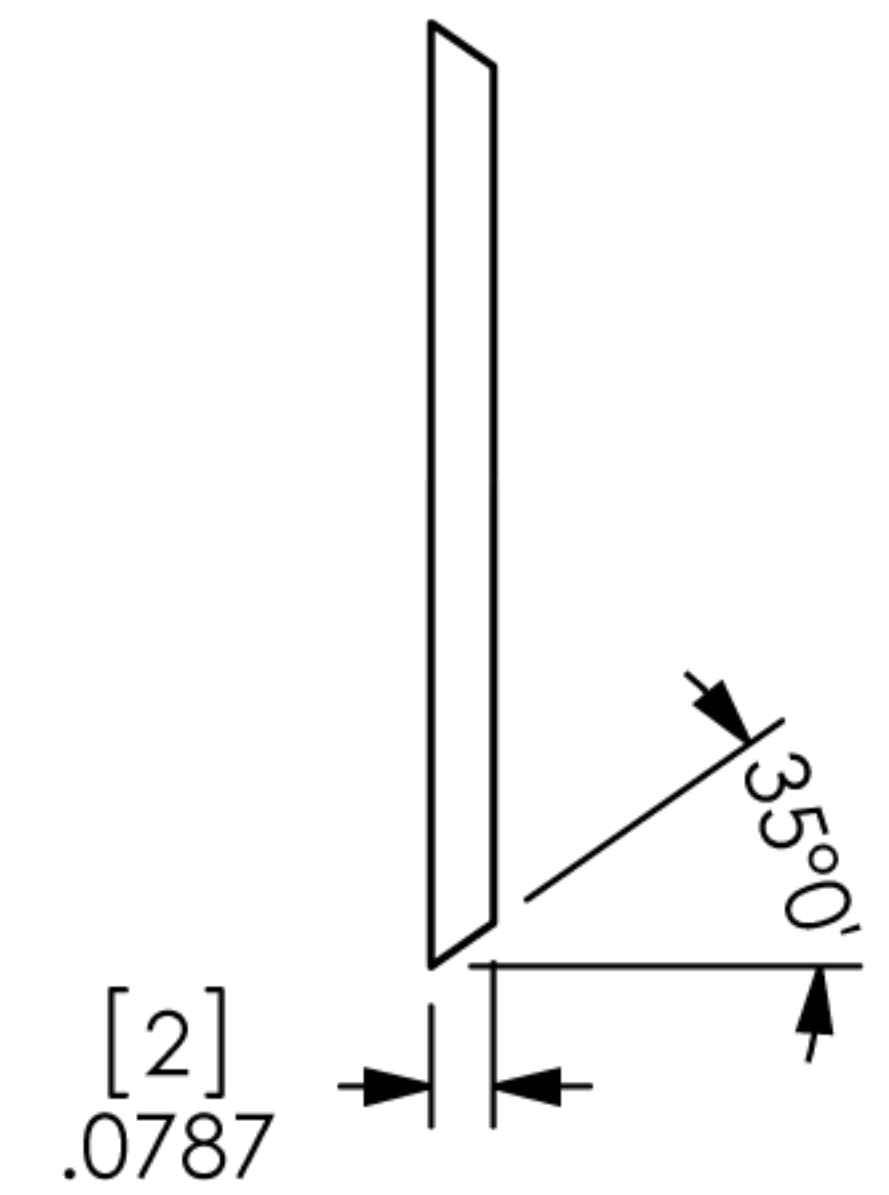
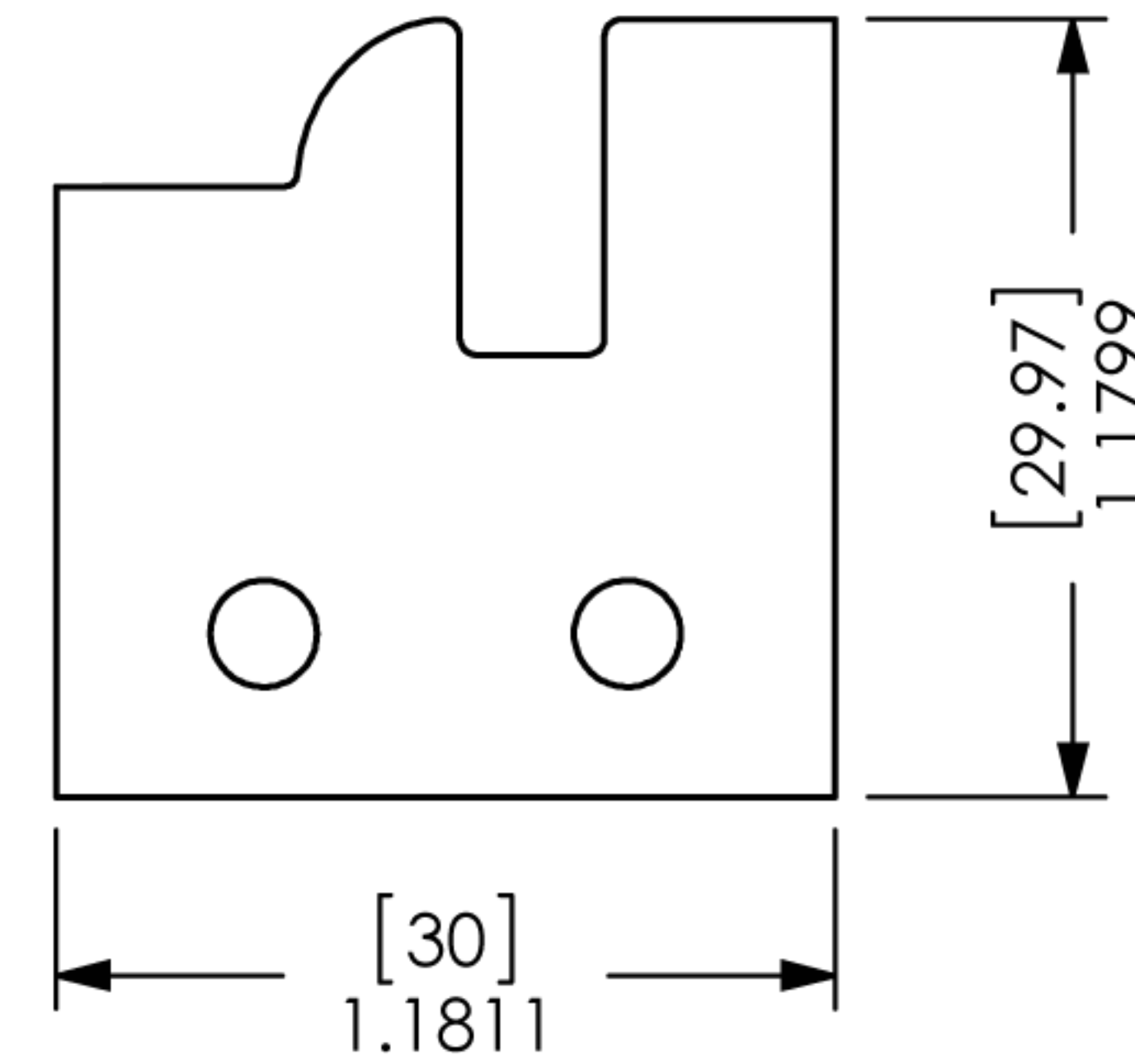
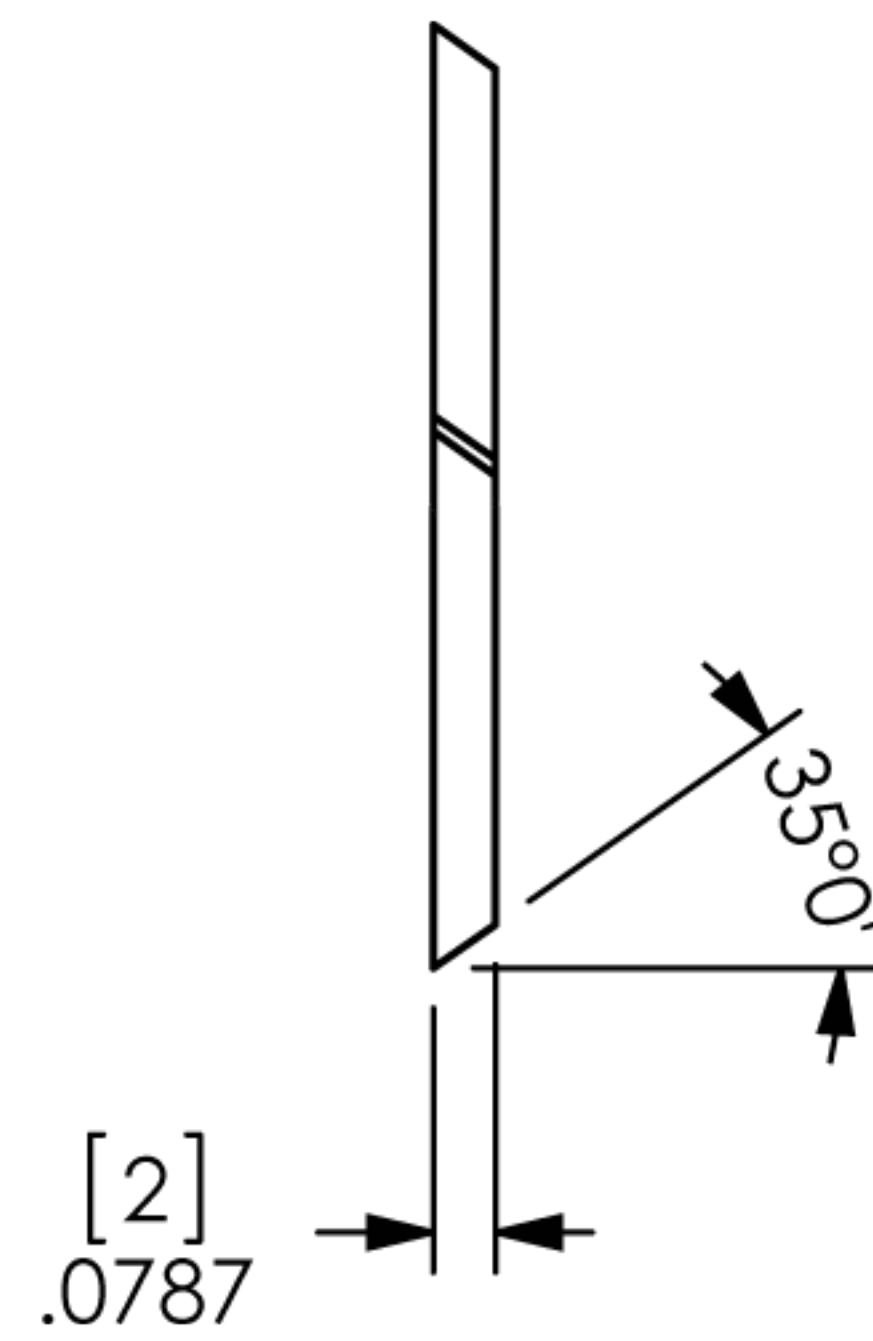
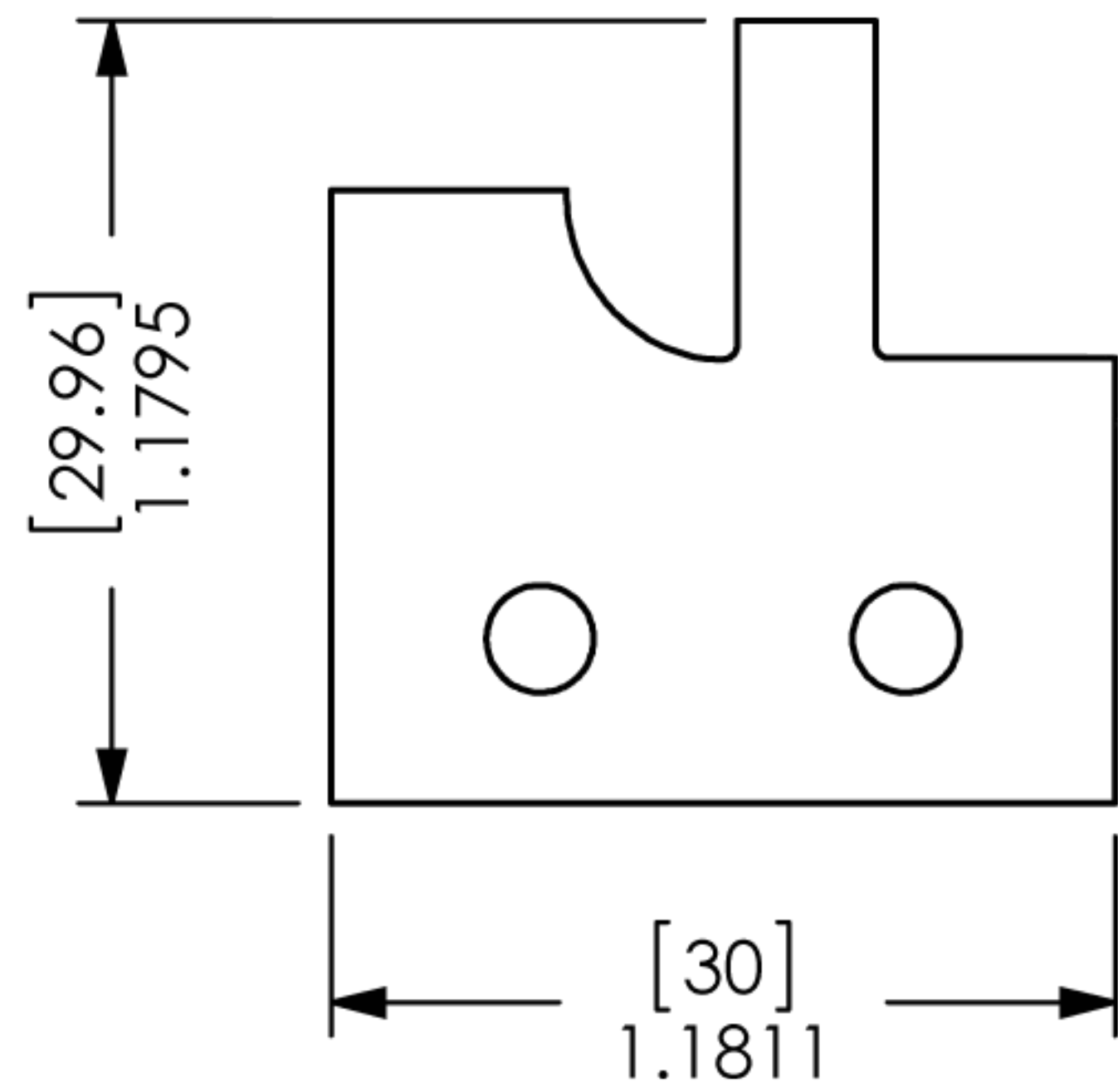

**PLEASE INDICATE
LOCATING SIDE
ON EACH INSERT**

ATTN: _____ DATE: _____ PO#: _____

**CUSTOM TOOLING MUST HAVE CUSTOMER APPROVAL PRIOR TO THE START OF
MANUFACTURING. PLEASE REVIEW THIS DRAWING FOR ACCURACY, INCLUDING
ROTATION, AND FAX A SIGNED AND DATED COPY TO 740-498-5454. PRODUCTION
WILL BEGIN UPON RECEIPT OF APPROVED DRAWING.**

APPROVED BY: _____ DATE: _____

HALL MANUFACTURING DWG: 4-10-2208700

**DATE:
3/20/12**

**DWN BY:
R.W.B.**

SHEET 1 OF 3