

# Roundover Bits

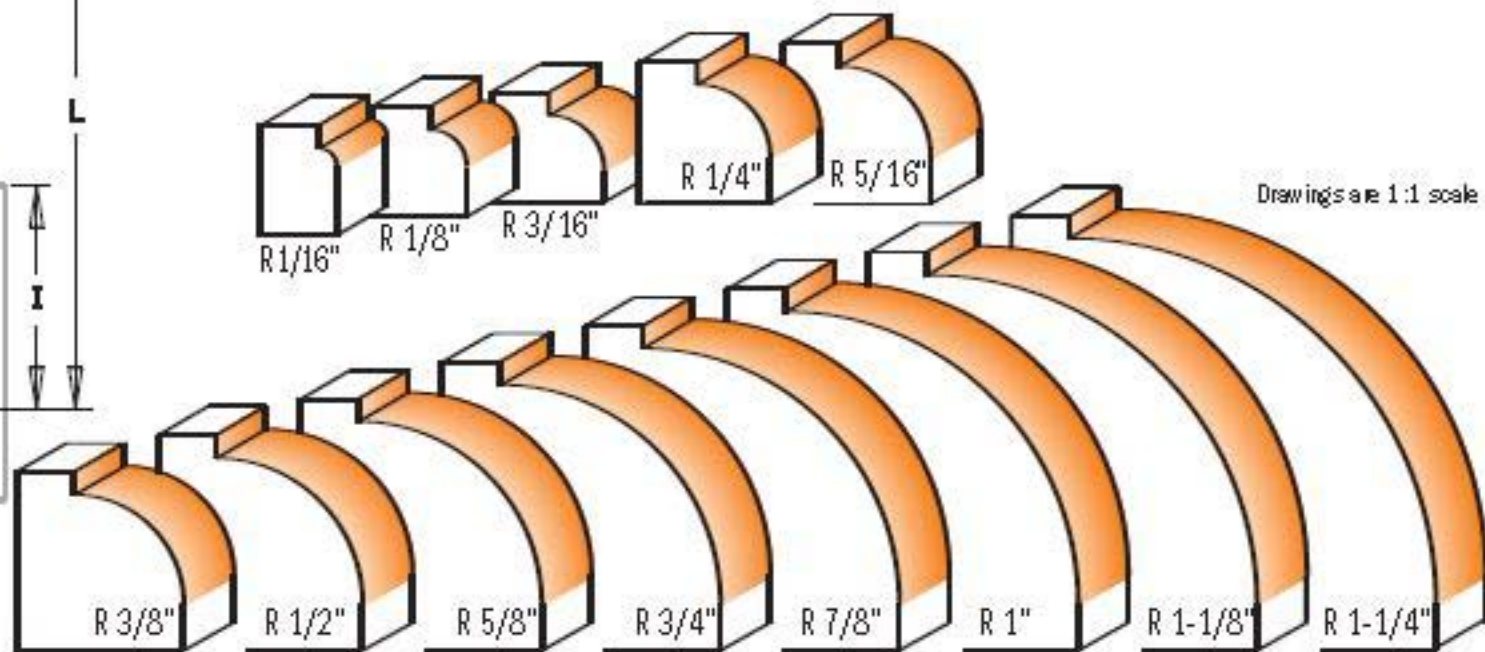

## 838

It's hard to find a profile bit that gets more work than a Roundover Bit. This shape is great for simple tasks like easing sharp corners, or for more intricate jobs like drop leaf tables (when used in conjunction with our Cove Bits of the same radius).

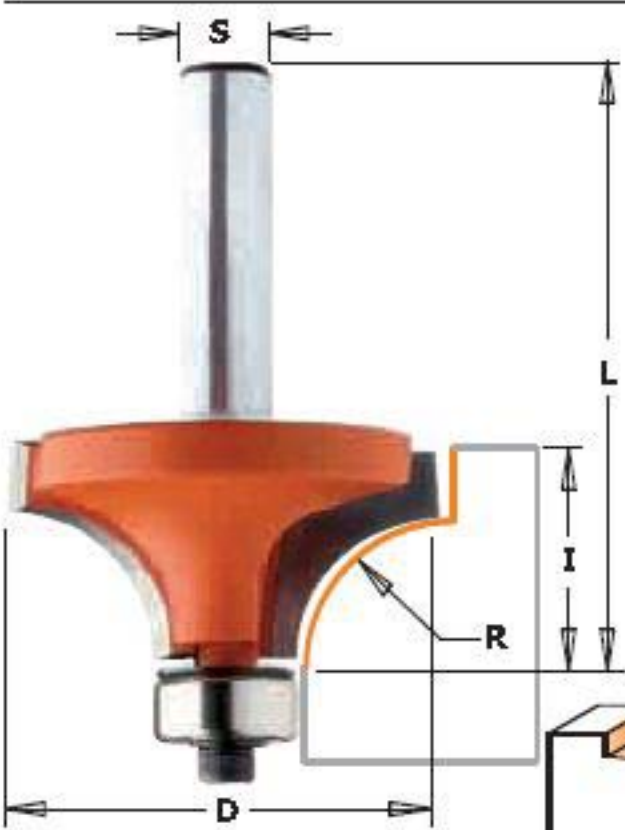

Drawings are 1:1 scale

ORDER NO. 1/4" shank	ORDER NO. 1/2" shank	R		D inches	I inches	L inches	Spare parts			
		inches	mm				Shield	Bearing	Screw TCEI	Hex key
838.160.11		1/16	1.6	5/8	1/2	2-5/32	990.423.00	791.003.00	990.058.00	991.057.00
838.190.11		1/8	3.2	3/4	1/2	2-5/32	990.423.00	791.003.00	990.058.00	991.057.00
838.222.11		3/16	4.75	7/8	1/2	2-5/32	990.423.00	791.003.00	990.058.00	991.057.00
838.254.11		1/4	6.35	1	1/2	2-5/32	990.423.00	791.003.00	990.058.00	991.057.00
	838.754.11	1/4	6.35	1	1/2	2-25/64	990.423.00	791.003.00	990.058.00	991.057.00
838.285.11		5/16	7.95	1-1/8	1/2	2-5/32	990.423.00	791.003.00	990.058.00	991.057.00
838.317.11		3/8	9.52	1-1/4	9/16	2-13/64	990.423.00	791.003.00	990.058.00	991.057.00
	838.817.11	3/8	9.52	1-1/4	9/16	2-7/16	990.423.00	791.003.00	990.058.00	991.057.00
838.380.11		1/2	12.7	1-1/2	3/4	2-25/64	990.423.00	791.003.00	990.058.00	991.057.00
	838.830.11	1/2	12.7	1-1/2	3/4	2-41/64	990.423.00	791.003.00	990.058.00	991.057.00
838.445.11		5/8	15.9	1-3/4	7/8	2-17/32	990.423.00	791.003.00	990.058.00	991.057.00
	838.945.11	5/8	15.9	1-3/4	7/8	2-27/32	990.423.00	791.003.00	990.058.00	991.057.00
	838.990.11	3/4	19	2	1	2-57/64	990.423.00	791.003.00	990.058.00	991.057.00
	838.991.11	7/8	22.2	2-1/4	1-1/8	3-1/32	990.423.00	791.003.00	990.058.00	991.057.00
	838.992.11*	1	25.4	2-1/2	1-5/16	3-13/64	990.423.00	791.003.00	990.058.00	991.057.00
	838.993.11*	1-1/8	28.6	3	1-1/2	3-33/64	541.550.00	791.004.00	990.058.00	991.057.00
	838.994.11*	1-1/4	31.7	3-1/4	1-3/4	3-49/64	541.550.00	791.004.00	990.058.00	991.057.00
	838.996.11*	1-1/2	38.1	3-1/2	1-3/4	3-21/32	990.423.00	791.003.00	990.058.00	991.057.00