

Solid Surface Edge Profile Bits

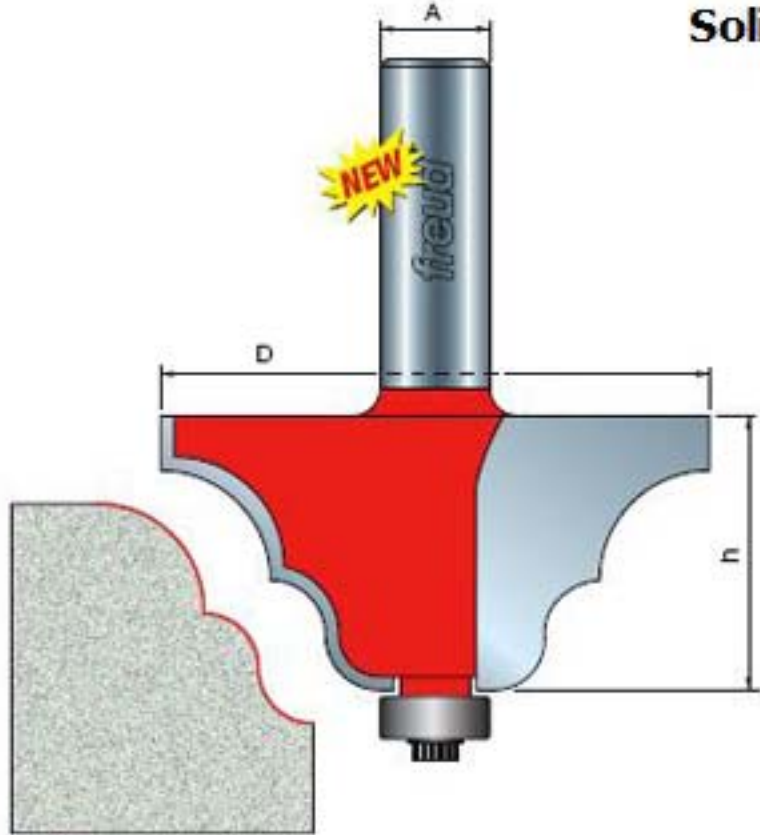

85-130

Application: Decorative edges on all solid surface tops

- Specially formulated carbide is ideal for fabricating solid surface materials.
- Cuts all solid surface materials.
- Use in hand-held portable routers.

Item #	Overall Dia.(D)	Carbide Height(h)	Shank Dia.(A)	Bearing Type
85-101	3"	1-1/8"	1/2"	Synthetic
85-103	2-3/4"	1-1/4"	1/2"	Steel
85-104	3"	1-3/8"	1/2"	Synthetic
85-105	2-1/2"	1-1/8"	1/2"	Synthetic
85-106	2-1/4"	1-1/4"	1/2"	Steel
85-108	2-1/2"	1-1/4"	1/2"	Steel
85-109	2-3/4"	1-5/8"	1/2"	Synthetic
85-110	1-1/2"	2"	1/2"	Steel
85-111	2-1/2"	1-1/2"	1/2"	Steel
85-113	2-1/2"	1-3/4"	1/2"	Steel
85-115	3-1/8"	1"	1/2"	Steel
85-117	2-3/8"	1-3/16"	1/2"	Steel
85-118	1-11/16"	3/4"	1/2"	Steel
85-125	2"	1-1/8"	1/2"	Steel
85-126	1-3/4"	1/2"	1/2"	Steel
85-127	2-1/8"	1"	1/2"	Steel
85-130	2-1/2"	1-1/4"	1/2"	Steel
85-131	2"	7/8"	1/2"	Steel
85-133	1-3/4"	1-1/4"	1/2"	Steel
85-135	1-5/16"	1-1/16"	1/2"	Synthetic