

GEOMETRY	
2 Wing(s)	
0° Hook	
-5° Shear	
Minor Diameter	
Major Diameter	.500"

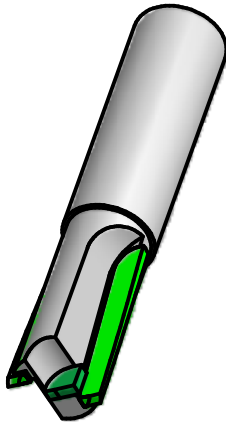

DETAIL D
SCALE 2 : 1

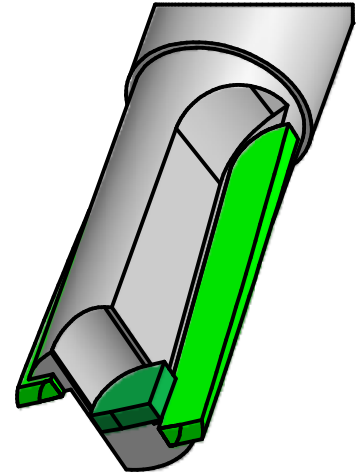

Includes a separate tip for plunge cut

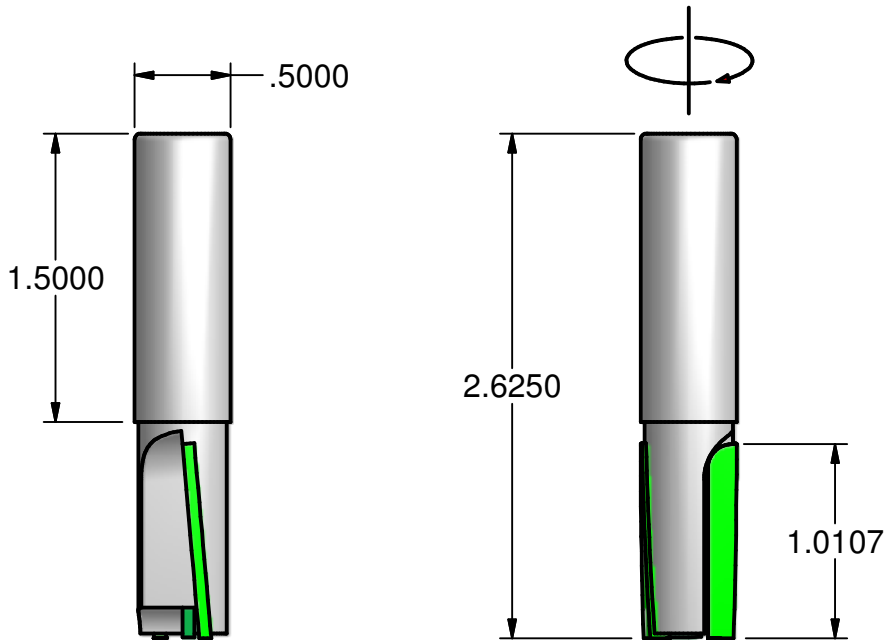

Tips have a down shear

THIS DRAWING IS PROPERTY OF EW TOOLING, INC. AND MUST NOT BE USED IN ANY WAY DETRIMENTAL TO OUR INTERESTS

182 Hall Manufacturing Solutions

E.W. TOOLING, INC.

Cutting tools for the woodworking industry

Approved by: _____

Originate: 4/20/09

Last edit: 4/20/09

EW P/N: 182-200

Tips: .0625"

Diamond

Cust P/N: