

# Cope & Pattern (6 Cutter Sets)

## MINI-PRO cutters

- 3 wing • 2-15/16" diameter
- 3/4" bore • Runs with a 2-3/16" diam. rub bearing (AM-90-035)

## PRO-LINE cutters

- 3 wing • 4" diameter
- 1-1/4" bore • Runs with a 3-1/4" diam. rub bearing (AP-90-052)

Versatile and easy-to-use. These 6 cutter sets are designed to perform the 3 functions shown. Our standard sets cut 1/4" wide x 3/8" deep tongue and groove.

Our common minor diameter requires NO fence adjustment when changing from cope to pattern cuts (3/8" tongue only).

Counterclockwise rotation with wood fed face down.

For optional tongue and groove cutters and eased edge option, see Center Groover Sets and Optional Eased Edge Sets.



**Cope & Pattern**  
3/4" to 1-1/8" material

M C 50-010 P C 10-010  
M T 50-010 P T 10-010



**Glass Panel**  
3/4" to 1" material



**Tongue & Groove**  
3/4" material



M C 50-015 P C 10-015  
M T 50-015 P T 10-015



M C 50-020 P C 10-020  
M T 50-020 P T 10-020



M C 50-025 P C 10-025  
M T 50-025 P T 10-025



M C 50-030 P C 10-030  
M T 50-030 P T 10-030



M C 50-035 P C 10-035  
M T 50-035 P T 10-035



For **opposite rotation**, add 20% to the suggested list price.

See **custom cutter** ordering information on inside back cover. Same day quoting.

Wood samples shown actual size.

For eased edges add 20% to the suggested list price.

**PRODUCT ORDER CODE**

**M C** 00-000 **P C** 00-000  
**M T** 00-000 **P T** 00-000

M - MINI-PRO (3/4" Bore)  
 P - PRO-LINE (1-1/4" Bore)  
 C - Carbide Tip (Orange)  
 T - T-Alloy Tip (Yellow)

**Cope & Pattern (6 Cutter Sets)**

**3/4" to 1-1/8" material**

**Cope & Pattern**

3/4" to 1-1/8" material

**M C** 50-040 **P C** 10-040  
**M T** 50-040 **P T** 10-040



**Glass Panel**

3/4" to 1" material



**Tongue & Groove**

3/4" material



**M C** 50-045 **P C** 10-045  
**M T** 50-045 **P T** 10-045



**M C** 50-050 **P C** 10-050  
**M T** 50-050 **P T** 10-050



**M C** 50-060 **P C** 10-060  
**M T** 50-060 **P T** 10-060



**M C** 50-070 **P C** 10-070  
**M T** 50-070 **P T** 10-070



**M C** 50-500 **P C** 10-500  
**M T** 50-500 **P T** 10-500



For **opposite rotation**, add 20% to the suggested list price.

See **custom cutter** ordering information on inside back cover. Same day quoting.

Wood samples shown actual size.

For eased edges add 20% to the suggested list price.

**1" to 1-3/8" material**

**Cope & Pattern**

**M C** 50-145 **P C** 10-145  
**M T** 50-145 **P T** 10-145



**Glass Panel**



**Tongue & Groove**



# Double Sided Cope & Pattern (6 Cutter Sets)

Standard sets cut 1/4" wide x 3/8" deep tongue and groove.

For optional tongue and groove cutters and eased edge option, see Center Groover Sets and Optional Eased Edge Sets.



M	C	50-310	P	C	10-310
M	T	50-310	P	T	10-310



M	C	50-320	P	C	10-320
M	T	50-320	P	T	10-320



M	C	50-340	P	C	10-340
M	T	50-340	P	T	10-340

## 1" to 1-1/4" material

# Center Groover Sets (2 Piece Sets)

At time of purchase, you may substitute the following tongue & groove cutters for the standard tongue & groove cutters in your cope & pattern set, at no additional charge. If you choose an optional center groover set, you will be unable to do the tongue & groove option

Available on all M-50 and P-10 series cope & patterns. Diameters will no longer be the same, requiring fence adjustments between cuts.



See **custom cutter** ordering information on inside back cover. Same day quoting. Wood samples shown actual size.

### PRODUCT ORDER CODE

M	C	00-000	P	C	00-000
M	T	00-000	P	T	00-000

M - MINI-PRO (3/4" Bore)  
 P - PRO-LINE (1-1/4" Bore)  
 C - Carbide Tip (Orange)  
 T - Alloy Tip (Yellow)

## Center Groovers Only - Profile cutters not included



M	C	50-501	P	C	10-501
M	T	50-501	P	T	10-501



M	C	50-604	P	C	10-604
M	T	50-604	P	T	10-604

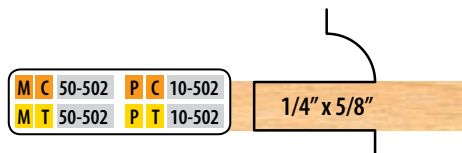

M	C	50-502	P	C	10-502
M	T	50-502	P	T	10-502



M	C	50-605	P	C	10-605
M	T	50-605	P	T	10-605

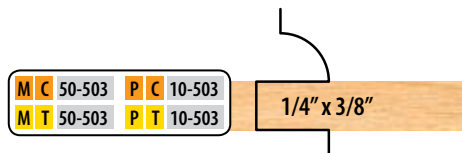

M	C	50-503	P	C	10-503
M	T	50-503	P	T	10-503



M	C	50-607	P	C	10-607
M	T	50-607	P	T	10-607

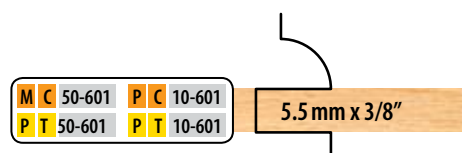

M	C	50-601	P	C	10-601
P	T	50-601	P	T	10-601

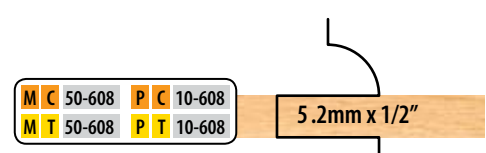

M	C	50-608	P	C	10-608
M	T	50-608	P	T	10-608

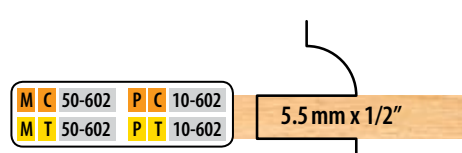

M	C	50-602	P	C	10-602
M	T	50-602	P	T	10-602

### Glass Option (for rubber extrusion)

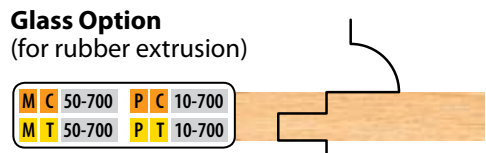

M	C	50-700	P	C	10-700
M	T	50-700	P	T	10-700

## Optional Eased Edge Sets



Eased edges are available on all 10 and 50 series cope & patterns. However, you cannot do glass panel or tongue & groove without custom groovers. Add 20% to the suggested list price.



### COPE & PATTERN STACKING INSTRUCTIONS



Each function of the 6 piece cope & pattern set requires a different cutter configuration. For desired results, use the following guide to set up each operation.

**REMEMBER:** Always stagger cutters when stacking. Never stack wing to wing.

### CHECK THE ALIGNMENT OF YOUR SPINDLE

1. Unplug your machine. Remove the fence and cutter.
2. Raise the spindle to its highest position and clamp a 12" - 18" steel straight edge between the collars of the spindle.
3. Lower the spindle until the straight edge almost touches the table top.
4. Rotate the spindle by hand, observing the gap between the table top and the straight edge. If this gap is not uniform, indicating shaft misalignment, shim the spindle cartridge, or table, as needed to correct.



## Spindle Alignment

**REMEMBER:** For a proper fit, your shaper must be aligned. Before using any shaper cutter, always check your spindle to ensure it is square with the shaper table. Misalignment here causes off pattern and fitting problems.



# Double Sided Cope & Pattern (8 Cutter Sets)

## MINI-PRO cutters

- 3 wing • 2-15/16" diameter
- 3/4" bore • Runs with a 1-11/16" diam. rub bearing (AM-90-027)

## PRO-LINE cutters

- 3 wing • 4" diameter
- 1-1/4" bore • Runs with a 2-3/4" diam. rub bearing (AP-90-044)

Standard sets cut 1/4" x 5/8" or 1/2" x 5/8" deep tongue and groove. Mini-Pro is not to be used on 1/2" spindle.

These 8 piece cutter sets are built to cut both 1-3/8" passage doors and 1-3/4" entry doors simply by changing the center cutters.

A 2 piece glass panel groover set is also available to run with these sets (see facing page).



M C 51-010 P C 11-010  
M T 51-010 P T 11-010

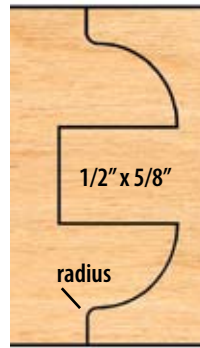

M C 51-011 P C 11-011  
M T 51-011 P T 11-011

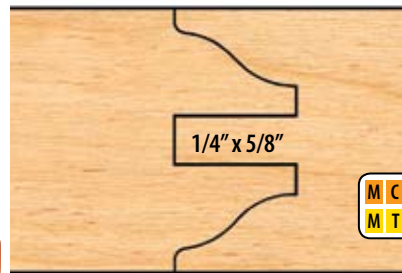

M C 51-020 P C 11-020  
M T 51-020 P T 11-020

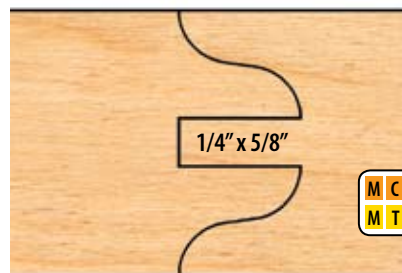

M C 51-030 P C 11-030  
M T 51-030 P T 11-030



M C 51-040 P C 11-040  
M T 51-040 P T 11-040

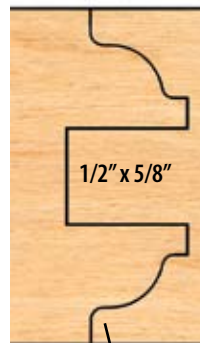

M C 51-041 P C 11-041  
M T 51-041 P T 11-041

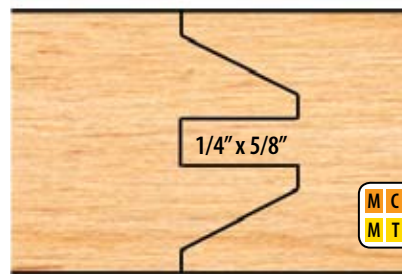

M C 51-050 P C 11-050  
M T 51-050 P T 11-050

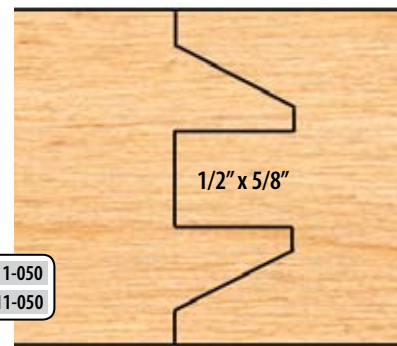

See **custom cutter** ordering information on inside back cover. Same day quoting.

Wood samples shown actual size.

**A 3/8" x 5/8" tongue option is available as a no charge exchange.**

**PRODUCT ORDER CODE**

<b>M C</b>	00-000	<b>P C</b>	00-000
<b>M T</b>	00-000	<b>P T</b>	00-000

M - MINI-PRO (3/4" Bore)  
 P - PRO-LINE (1-1/4" Bore)  
 C - Carbide Tip (Orange)  
 T - T-Alloy Tip (Yellow)

**Double Sided Cope & Pattern (8 Cutter Sets)**

**1-3/4" material**

**1-3/8" material**



<b>M C</b>	51-060	<b>P C</b>	11-060
<b>M T</b>	51-060	<b>P T</b>	11-060



*Eased edges are available for an additional 20%.*



<b>M C</b>	51-070	<b>P C</b>	11-070
<b>M T</b>	51-070	<b>P T</b>	11-070



See **custom cutter** ordering information on inside back cover. Same day quoting. Wood samples shown actual size.

**A 3/8" x 5/8" tongue option is available as a no charge exchange.**



<b>M C</b>	51-500	<b>P C</b>	11-500
<b>M T</b>	51-500	<b>P T</b>	11-500



**Optional Glass Panel Groovers (2 Cutter Sets)**



<b>M C</b>	52-010	<b>P C</b>	12-010
<b>M T</b>	52-010	<b>P T</b>	12-010



<b>M C</b>	52-020	<b>P C</b>	12-020
<b>M T</b>	52-020	<b>P T</b>	12-020

## Raised Panel Shaper Cutters (3/4" Material)

Our raised panel cutters are manufactured with 15° SHEAR to produce optimum cuts both with and across the grain.

Counterclockwise rotation with wood fed face up.



For **opposite rotation**, add 20% to the suggested list price.

### MINI-PRO cutters

- 3 wing • 4-1/2" diameter
- 3/4" bore • Runs with a 1-5/8" diam. rub bearing (AM-90-026)

### PRO-LINE cutters

- 3 wing • 6" diameter
- 1-1/4" bore • Runs with a 3" diam. rub bearing (AP-90-048)



## Raised Panel Shaper Cutters (1/2" Material)

Manufactured with 15° SHEAR to produce optimum cuts both with and across the grain.

Counterclockwise rotation with wood fed face up.

These raised panel cutters cut a 1-3/8" reveal plus a 3/8" long tongue.

Reduce production time by adding an opposite rotation cutter to those above, and produce double sided raised panels in a single pass.

Opposite rotation cutters are made to order. Please allow 7-10 days.

### PRO-LINE cutters

- 3 wing • 1-1/4" bore
- Designed to run with a 3" diameter rub bearing (AP-90-048)
- Available in Pro-Line only





### MINI-PRO cutters

- 3 wing • 4-1/2" diameter
- 3/4" bore • Runs with a 1-5/8" diam. rub bearing (AM-90-026)

### PRO-LINE cutters

- 3 wing • 6" diameter
- 1-1/4" bore • Runs with a 3" diam. rub bearing (AP-90-048)

## Raised Panel Shaper Cutters (5/8" Material)



For **opposite rotation**, add 20% to the suggested list price.

See **custom cutter** ordering information on inside back cover. Same day quoting.

Wood samples shown actual size.

Use with a back cutter to cut 3/4" material.

## Back Cutters - Raised Panel (3/4" Material)

### MINI-PRO cutters

- 3 wing • 3-3/8" diameter
- 3/4" bore

*Does not include Raised Panel Cutter*

### PRO-LINE cutters

- 3 wing • 4-3/4" diameter
- 1-1/4" bore

Use with a 55/15 series raised panel for 3/4" material.

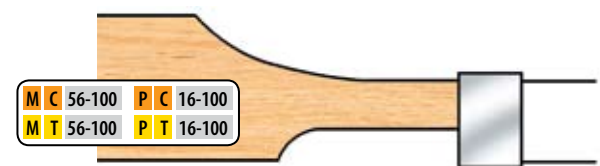

## Raised Panel Tongue Trimmer

### MINI-PRO cutters

- 3 wing • 1-5/8" diameter
- 3/4" bore

*Does not include Raised Panel Cutter*

### PRO-LINE cutters

- 3 wing • 3" diameter
- 1-1/4" bore



# Door Edge Detail Shaper Cutters

## MINI-PRO cutters

- 3 wing • 2-15/16" diameter
- 3/4" bore • 1" wide tips

## PRO-LINE cutters

- 3 wing • 4" diameter
- 1-1/4" bore • 1" wide tips

All of these wood samples are full scale as shown. Whether it is a 30° back bevel, fingerpull, 3/8" offset, or flush overlay door, we offer a wide selection to choose from.

Counterclockwise rotation with wood fed face up.

For more profiles go to Door Edge Details page.

If you don't see what you need, check out our custom cutter page on the inside back cover.



<b>M C</b> 57-001 <b>P C</b> 17-001 <b>M T</b> 57-001 <b>P T</b> 17-001	<b>M C</b> 57-002 <b>P C</b> 17-002 <b>M T</b> 57-002 <b>P T</b> 17-002	<b>M C</b> 57-003 <b>P C</b> 17-003 <b>M T</b> 57-003 <b>P T</b> 17-003
<b>M C</b> 57-004 <b>P C</b> 17-004 <b>M T</b> 57-004 <b>P T</b> 17-004	<b>M C</b> 57-005 <b>P C</b> 17-005 <b>M T</b> 57-005 <b>P T</b> 17-005	<b>M C</b> 57-006 <b>P C</b> 17-006 <b>M T</b> 57-006 <b>P T</b> 17-006
<b>M C</b> 57-007 <b>P C</b> 17-007 <b>M T</b> 57-007 <b>P T</b> 17-007	<b>M C</b> 57-008 <b>P C</b> 17-008 <b>M T</b> 57-008 <b>P T</b> 17-008	<b>M C</b> 57-009 <b>P C</b> 17-009 <b>M T</b> 57-009 <b>P T</b> 17-009
<b>M C</b> 57-010 <b>P C</b> 17-010 <b>M T</b> 57-010 <b>P T</b> 17-010	<b>M C</b> 57-011 <b>P C</b> 17-011 <b>M T</b> 57-011 <b>P T</b> 17-011	<b>M C</b> 57-012 <b>P C</b> 17-012 <b>M T</b> 57-012 <b>P T</b> 17-012
<b>M C</b> 57-013 <b>P C</b> 17-013 <b>M T</b> 57-013 <b>P T</b> 17-013	<b>M C</b> 57-014 <b>P C</b> 17-014 <b>M T</b> 57-014 <b>P T</b> 17-014	<b>M C</b> 57-015 <b>P C</b> 17-015 <b>M T</b> 57-015 <b>P T</b> 17-015
<b>M C</b> 57-016 <b>P C</b> 17-016 <b>M T</b> 57-016 <b>P T</b> 17-016	<b>M C</b> 57-017 <b>P C</b> 17-017 <b>M T</b> 57-017 <b>P T</b> 17-017	<b>M C</b> 57-018 <b>P C</b> 17-018 <b>M T</b> 57-018 <b>P T</b> 17-018
<b>M C</b> 57-019 <b>P C</b> 17-019 <b>M T</b> 57-019 <b>P T</b> 17-019	<b>M C</b> 57-020 <b>P C</b> 17-020 <b>M T</b> 57-020 <b>P T</b> 17-020	<b>M C</b> 57-021 <b>P C</b> 17-021 <b>M T</b> 57-021 <b>P T</b> 17-021
<b>M C</b> 57-022 <b>P C</b> 17-022 <b>M T</b> 57-022 <b>P T</b> 17-022	<b>M C</b> 57-023 <b>P C</b> 17-023 <b>M T</b> 57-023 <b>P T</b> 17-023	
<b>M C</b> 57-024 <b>P C</b> 17-024 <b>M T</b> 57-024 <b>P T</b> 17-024	<b>M C</b> 57-029 <b>P C</b> 17-029 <b>M T</b> 57-029 <b>P T</b> 17-029	

For **opposite rotation**, add 20% to the suggested list price.

Wood samples shown actual size.

57-029 has 4" diameter  
17-029 has 4-1/2" diameter  
For this finger pull detail, the wood is cut at a 30° incline.

### MINI-PRO cutters

- 3 wing
- 3/4" bore • 1" wide tips

### PRO-LINE cutters

- 3 wing
- 1-1/4" bore • 1" wide tips

## Door Edge Detail Bevel Cutters

For a different angle or a wider bevel cutter than those shown, ask our custom cutter department for a quote (See Custom Tooling Page of web site).

All bevel cutters are open body style.



22.5° Bevel

M	C	57-031	P	C	17-031
M	T	57-031	P	T	17-031



30° Bevel



45° Bevel

M	C	57-026	P	C	17-026
M	T	57-026	P	T	17-026



M	C	57-028	P	C	17-028
M	T	57-028	P	T	17-028

### MINI-PRO cutters

2-15/16" diameter

### PRO-LINE cutters

- 3 wing
- 1-1/4" bore • 4" diameter

## Bead Cutters



M	C	57-040	P	C	17-040
M	T	57-040	P	T	17-040

M	C	57-041	P	C	17-041
M	T	57-041	P	T	17-041

M	C	57-042	P	C	17-042
M	T	57-042	P	T	17-042

M	C	57-043	P	C	17-043
M	T	57-043	P	T	17-043

## Table Saw Bead Cutters

- 6 wing
- 5/8" bore
- 8" diameter

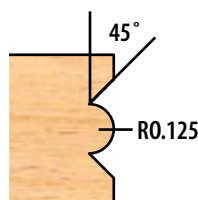

TSB-1



TSB-2

# Door Edge Details (32mm Hinge System)

## MINI-PRO cutters

- 3 wing - 2-1/16" minor diameter
- 3/4" bore

## PRO-LINE cutters

- 3 wing - 3-1/16" minor diameter
- 1-1/4" bore

Major diameter varies with depth of cut

### Part number is for top cutter only.

Manufactured with 15° SHEAR to produce optimum cuts both with and across grain.

Counterclockwise rotation with wood fed face up.

Any top cutter is designed to nest and run with any bottom cutter.

## Top Cutter Profiles 3/4" to 7/8" material



For **opposite rotation**, add 20% to the suggested list price.

See **custom cutter** ordering information on inside back cover. Same day quoting.

Wood samples shown actual size.

← This same cutter can also be set-up to run on 7/8"-1" material as shown.

## Bottom Cutter Profiles

Bottom cutters for 32mm Hinge Systems are designed to nest and run with any top cutter listed.

Selection of bottom cutter should depend upon the distance of the bored hole for the hinge from the edge of the door.

Manufactured to the same specifications as all top cutters.



**PRODUCT ORDER CODE**

**M C** 00-000 **P C** 00-000  
**M T** 00-000 **P T** 00-000

M - MINI-PRO (3/4" Bore)  
 P - PRO-LINE (1-1/4" Bore)  
 C - Carbide Tip (Orange)  
 T - T-Alloy Tip (Yellow)

**Door Edge Details (32mm Hinge System)**

**Top Cutter Profiles 7/8" to 1" material**



**Part number is for top cutter only.**



**See custom cutter** ordering information on inside back cover. Same day quoting.  
 Wood samples shown actual size.

**MINI-PRO cutters**

2-15/16" diameter

**PRO-LINE cutters**

- 3 wing - 5" diameter
- 1-1/4" bore

**Drawer Lock Cutter**

Run drawer front face up in horizontal position over the top of the cutter. Drawer sides are run on end in a vertical position against the shaper fence. Made to cut up to 3/4" drawer sides. Counterclockwise rotation only.



**M C** 69-001 **P C** 29-001  
**M T** 69-001 **P T** 29-001

**MINI-PRO cutters**

2-15/16" diameter

**PRO-LINE cutters**

- 3 wing - 4" diameter
- 1-1/4" bore

**Matched Drop Leaf**

Counterclockwise rotation with wood face down. When running counterclockwise, cove cut is made by lowering shaper spindle to cut with the top half of the cutter. Bead cut is made by raising shaper spindle to cut with the bottom half of the cutter.



**M C** 66-001 **P C** 26-001  
**M T** 66-001 **P T** 26-001



### MINI-PRO cutters

- 3 wing • 2-15/16" diameter
- 3/4" bore • 1" wide tips
- Cuts from 1/2" to 7/8" material

### PRO-LINE cutters

- 3 wing • 2-15/16" diameter
- 1-1/4" bore • 2" wide tips
- Cuts from 1/2" to 1-7/8" material

## Reversible Glue Joint

Creates an incredibly strong joint by interlocking the glue surfaces.



## V-Paneling Shaper Cutter Set

The V-Paneling set consists of 5 cutters and 1 spacer to perform these 4 functions.

Counterclockwise rotation with wood fed face down.

See custom cutter ordering information on inside back cover. Same day quoting.

Wood samples shown actual size.

### MINI-PRO cutters

- 3 wing • 2-15/16" diameter
- 3/4" bore • Designed to run with 2-3/16" diam. rub bearing

### PRO-LINE cutters

- 3 wing • 4" diameter
- 1-1/4" bore • Designed to run with 3-1/4" diam. rub bearing



3/4" to 1" material



M C 59-010 P C 19-010  
M T 59-010 P T 19-010

7/8"

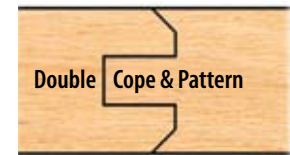

## 7-PC. Flooring Set

The flooring set consists of 6 cutters and 1 spacer to perform these 5 functions.

Cut provides a loose fit (.030) for wood expansion. Set up instructions included.

Counterclockwise rotation with wood fed face down.

3/4" to 1" material

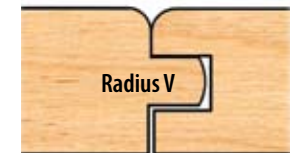
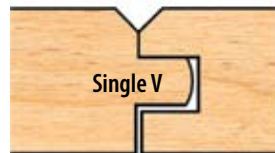

M C 59-020 P C 19-020  
M T 59-020 P T 19-020

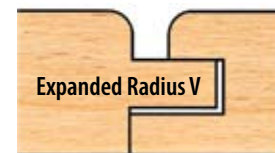
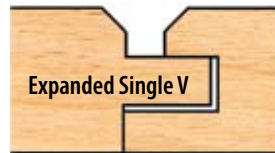

## 5-PC. Flooring Set with Nail Slot

### MINI-PRO cutters

- 3 wing • 2-15/16" diameter
- 3/4" bore

### PRO-LINE cutters

- 3 wing • 4" diameter
- 1-1/4" bore

This set includes 5 cutters to perform the cut as shown.

Counterclockwise rotation with wood fed face down. Up to 1" material

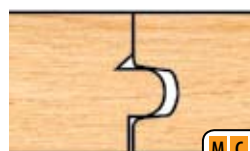

M C 59-030 P C 19-030  
M T 59-030 P T 19-030

## 8-PC. Flooring / V-Panel Set

1/2" material

### MINI-PRO cutters

- 3 wing • 2-15/16" diameter
- 3/4" bore

### PRO-LINE cutters

- 3 wing • 4" diameter
- 1-1/4" bore

M C 59-040 P C 19-040  
M T 59-040 P T 19-040

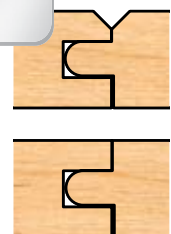

### MINI-PRO cutters

- 3 wing • 2-15/16" diameter
- 3/4" bore

### PRO-LINE cutters

- 3 wing • 4" diameter
- 1-1/4" bore

## Quarter Cove Convex Cutters

Number				Radius
M C 60-002	M T 60-002	P C 20-002	P T 20-002	1/8"
M C 60-004	M T 60-004	P C 20-004	P T 20-004	1/4"
M C 60-006	M T 60-006	P C 20-006	P T 20-006	3/8"
M C 60-008	M T 60-008	P C 20-008	P T 20-008	1/2"
M C 60-012	M T 60-012	P C 20-012	P T 20-012	3/4"



Counterclockwise rotation with wood fed face down.

### MINI-PRO cutters

- 3 wing • 2-15/16" diameter
- 3/4" bore • 1" wide tips

### PRO-LINE cutters

- 3 wing • 4" diameter
- 1-1/4" bore • 1" wide tips

Counterclockwise rotation with wood fed face up.



## Reversible Pattern Detail

After machining two pieces of wood, one piece may be inverted and plugged into its mate, forming a matched joint.



### MINI-PRO cutters

- 3 wing • 2-15/16" diameter
- 3/4" bore • Designed for use with 2-15/16" diam. rub bearing for flush trim application

### PRO-LINE cutters

- 3 wing • 4" diameter
- 1-1/4" bore • Designed for use with 4" diam. rub bearing for flush trim application

## Straight Top Groovers

Number				Width
M C 62-002	M T 62-002	P C 22-002	P T 22-002	1/8"
M C 62-004	M T 62-004	P C 22-004	P T 22-004	1/4"
M C 62-005	M T 62-005	P C 22-005	P T 22-005	5/16"
M C 62-006	M T 62-006	P C 22-006	P T 22-006	3/8"
M C 62-007	M T 62-007	P C 22-007	P T 22-007	7/16"
M C 62-008	M T 62-008	P C 22-008	P T 22-008	1/2"
M C 62-010	M T 62-010	P C 22-010	P T 22-010	5/8"
M C 62-012	M T 62-012	P C 22-012	P T 22-012	3/4"
M C 62-014	M T 62-014	P C 22-014	P T 22-014	7/8"
M C 62-016	M T 62-016	P C 22-016	P T 22-016	1"
M C 62-020	M T 62-020	P C 22-020	P T 22-020	1-1/4"
M C 62-024	M T 62-024	P C 22-024	P T 22-024	1-1/2"
M C 62-028	M T 62-028	P C 22-028	P T 22-028	1-3/4"
M C 62-032	M T 62-032	P C 22-032	P T 22-032	2"



Straight Top Groovers are ideal for cutting grooves, rabbets, and for flush trimming.



### MINI-PRO cutters

- 3 wing • 2-15/16" diameter
- 3/4" bore

### PRO-LINE cutters

- 3 wing • 4" diameter
- 1-1/4" bore

## Half Round Convex Shaper Cutters

Number				Width	Radius
M C 63-002	M T 63-002	P C 23-002	P T 23-002	1/4"	1/8"
M C 63-003	M T 63-003	P C 23-003	P T 23-003	3/8"	3/16"
M C 63-004	M T 63-004	P C 23-004	P T 23-004	1/2"	1/4"
M C 63-006	M T 63-006	P C 23-006	P T 23-006	3/4"	3/8"
M C 63-008	M T 63-008	P C 23-008	P T 23-008	1"	1/2"



Flute



### MINI-PRO cutters

- 3 wing • 2-15/16" diameter
- 3/4" bore

### PRO-LINE cutters

- 3 wing • 4" diameter
- 1-1/4" bore

## Half Round Concave Shaper Cutters

Number				Opening Width	Radius
M C 64-002	M T 64-002	P C 24-002	P T 24-002	1/4"	1/8"
M C 64-003	M T 64-003	P C 24-003	P T 24-003	3/8"	3/16"
M C 64-004	M T 64-004	P C 24-004	P T 24-004	1/2"	1/4"
M C 64-006	M T 64-006	P C 24-006	P T 24-006	3/4"	3/8"
M C 64-008	M T 64-008	P C 24-008	P T 24-008	1"	1/2"
M C 64-009	M T 64-009	P C 24-009	P T 24-009	1-1/8"	9/16"
M C 64-010	M T 64-010	P C 24-010	P T 24-010	1-1/4"	5/8"
		P C 24-012	P T 24-012	1-1/2"	3/4"



Bullnose

All Concave Cutters have .030" flare for easy bull nosing.



# Corner Rounding Shaper Cutters

Larger PRO-LINE Cutters exceed the standard 4" diameter (see chart).

Counterclockwise rotation with wood fed face down.



## MINI-PRO cutters

- 3 wing • 2-15/16" diameter
- 3/4" bore

## PRO-LINE cutters

- 3 wing • 4" diameter (unless specified)
- 1-1/4" bore

Number (R = Opposite Rotation)				Radius	Diameter
M C	65-002	M T	65-002	1/8"	4"
M C	65-002R	M T	65-002R	1/8"	4"
M C	65-003	M T	65-003	3/16"	4"
M C	65-004	M T	65-004	1/4"	4"
M C	65-004R	M T	65-004R	1/4"	4"
M C	65-005	M T	65-005	5/16"	4"
M C	65-006	M T	65-006	3/8"	4"
M C	65-006R	M T	65-006R	3/8"	4"
M C	65-008	M T	65-008	1/2"	4"
M C	65-010	M T	65-010	5/8"	4"
M C	65-012	M T	65-012	3/4"	4"
P C	25-002	P T	25-002	7/8"	4-1/2"
P C	25-002R	P T	25-002R	1"	4-1/2"
P C	25-003	P T	25-003	1-1/4"	5"
P C	25-004	P T	25-004	1-1/2"	5-1/2"
P C	25-004R	P T	25-004R	1-3/4"	6-1/2"
P C	25-005	P T	25-005	2"	6-1/2"
P C	25-006	P T	25-006		
P C	25-006R	P T	25-006R		
P C	25-008	P T	25-008		
P C	25-010	P T	25-010		
P C	25-012	P T	25-012		
P C	25-014	P T	25-014		
P C	25-016	P T	25-016		
P C	25-020	P T	25-020		
P C	25-024	P T	25-024		
P C	25-028	P T	25-028		
P C	25-032	P T	25-032		

# Window Sash Cutter Set (4 Cutter Set)

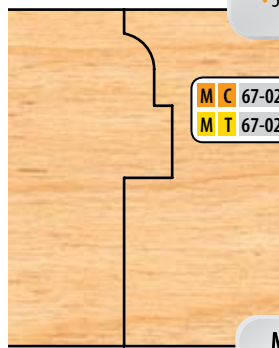

## MINI-PRO cutters

- 3 wing • 2-15/16" diameter
- 3/4" bore

## PRO-LINE cutters

- 3 wing • 4" diameter
- 1-1/4" bore

These window sash profiles are common in many older homes. They are made to cut stock up to 1-3/4".

Counterclockwise rotation with wood fed face down.

# Double Tongue & Groove Lock Mitre Cutter

Counterclockwise rotation only. Mini-Pro is made to run only on 3/4" spindle.

Part B is run flat in horizontal position on shaper table.

Part A is run in a vertical position against the shaper fence (see diagram).



## MINI-PRO cutters

- 3 wing • 4.05 diameter
- 3/4" bore • 1-1/8" wide tips
- Use on 3/4" spindles only

## PRO-LINE cutters

- 3 wing • 5.05 diameter
- 1-1/4" bore • 1-1/8" wide tips

# Single Tongue & Groove Lock Mitre Cutter (3 Cutter Set)

Counterclockwise rotation only. Mini-Pro is made to run only on 3/4" spindle.

Material to 1-1/8".

Part A and B are both run flat in horizontal position on shaper table. Part B is run again on table saw to cut groove (see diagram).



GCS-0806-1/4" TABLE SAW GROOVER Available in Carbide only as a stock item.

Use this solid head saw grooveover on your table saw to cut part "B" as shown. 8" diameter. 6 wing. Alternate shear face. 1/4" cut. 5/8" Bore.



### MINI-PRO cutters

- 3 wing • 2-15/16" diameter
- 3/4" bore

### PRO-LINE cutters

- 3 wing • 4" diameter
- 1-1/4" bore

## 1-Piece Double Easing Cutters

Custom rub bearings available for these cutters.

Number				Width	Radius
M C	71-006	M T	71-006	3/8"	1/8"
M C	71-008	M T	71-008	1/2"	1/8"
M C	71-012	M T	71-012	3/4"	1/8"
M C	71-016	M T	71-016	1"	1/8"
M C	71-020	M T	71-020	1-1/4"	1/8"
M C	71-024	M T	71-024	1-1/2"	1/8"



### MINI-PRO cutters

- 3 wing • 2-3/16" minor
- 3/4" bore

### PRO-LINE cutters

- 3 wing • 3" minor
- 1-1/4" bore

## 4-Piece Expandable Double Easing Set

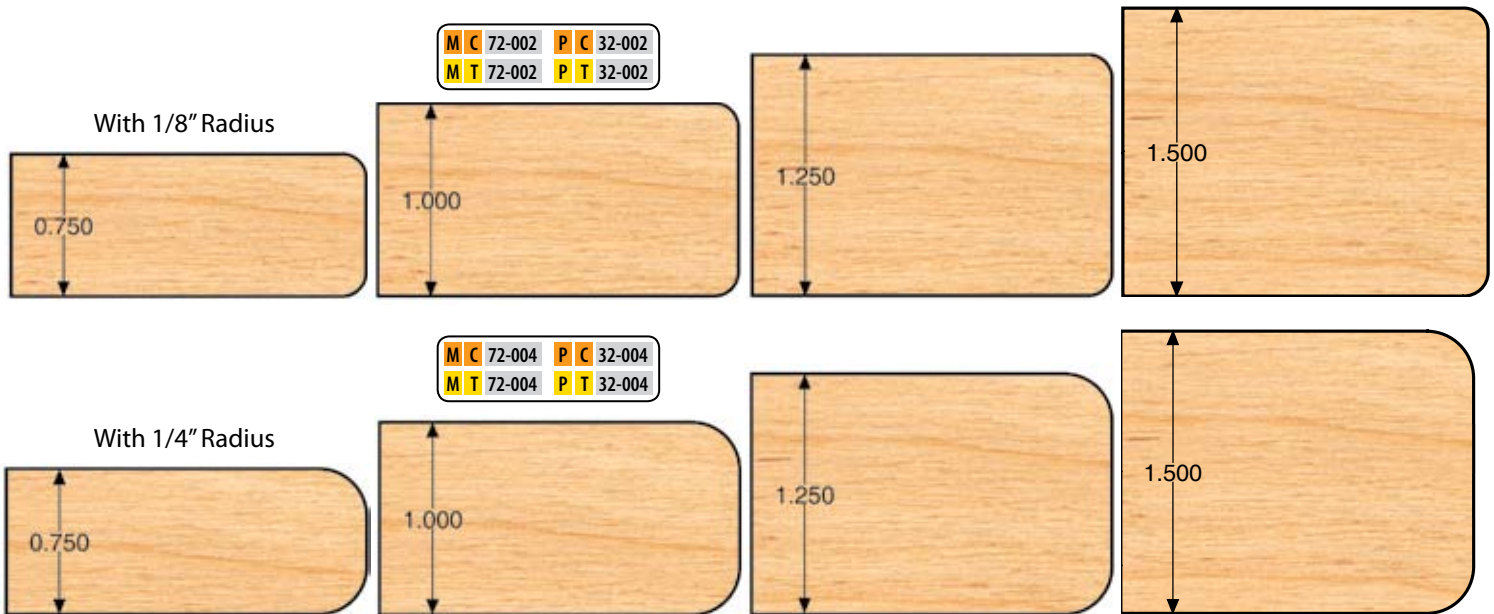

Each set includes 2 cutters and 2 spacers to cut 3/4", 1", 1-1/4" and 1-1/2" material.

### MINI-PRO cutters

- 3 wing • 2-15/16" diameter
- 3/4" bore

### PRO-LINE cutters

- 3 wing • 4" diameter
- 1-1/4" bore

## Extended Corner Rounds

Counterclockwise rotation with face down. For up to 1-1/4" material.

