

TEETH: 3
HOOK: 15°
SHEAR: 0°
TIPS: PCD
PA: 71.97mm

MAX RPM: 24,000

DWG: 1-01-5181000

A.K.A. #: N/A

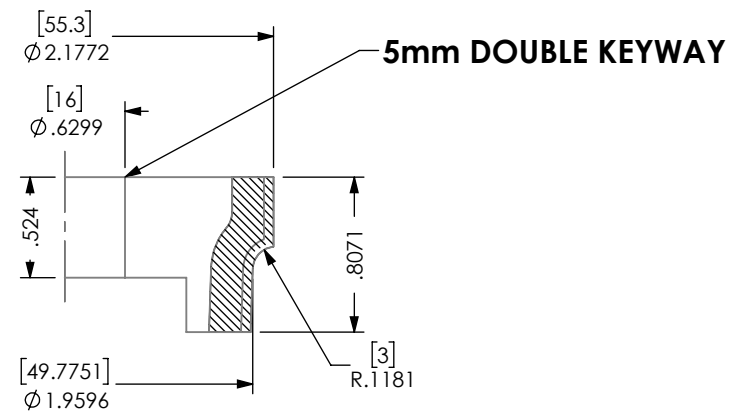
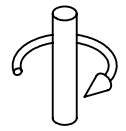

HALL MANUFACTURING DWG: 1-01-5181000

ATTN: _____ DATE: _____ PO#: _____

CUSTOM TOOLING MUST HAVE CUSTOMER APPROVAL PRIOR TO THE START OF MANUFACTURING. PLEASE REVIEW THIS DRAWING FOR ACCURACY, INCLUDING ROTATION, AND FAX A SIGNED AND DATED COPY. PRODUCTION WILL BEGIN UPON RECEIPT OF APPROVED DRAWING.

APPROVED BY: _____ DATE: _____

DATE:
10/7/21

DWN BY:
G.R.F.



REV.
+ SHEET 1 OF 5