

TEETH: 4
HOOK: 10°
SHEAR: 10°
TIPS: PCD
PA: 20.56mm

MAX RPM: 24,000

DWG: 1-01-3649900

A.K.A. #: N/A

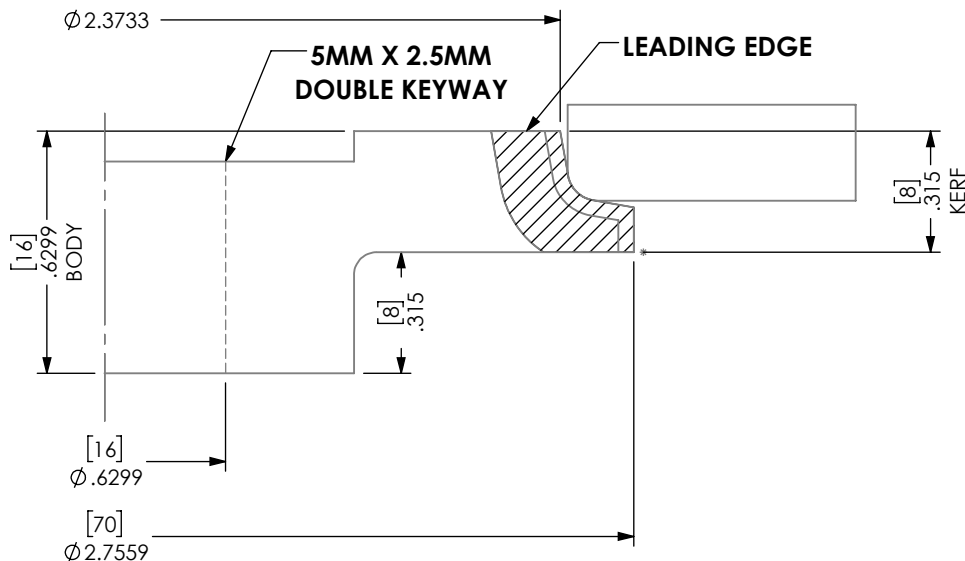
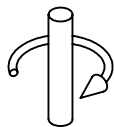

SCALED 2:1

HALL MANUFACTURING DWG: 1-01-3649900

ATTN: _____ DATE: _____ PO#: _____

CUSTOM TOOLING MUST HAVE CUSTOMER APPROVAL PRIOR TO THE START OF MANUFACTURING. PLEASE REVIEW THIS DRAWING FOR ACCURACY, INCLUDING ROTATION, AND FAX A SIGNED AND DATED COPY. PRODUCTION WILL BEGIN UPON RECEIPT OF APPROVED DRAWING.

APPROVED BY: _____ DATE: _____

DATE:
8/8/16

DWN BY:
W.J.L.



REV.
+

SHEET 1 OF 3